

Inspection Window IP54 - 9006518

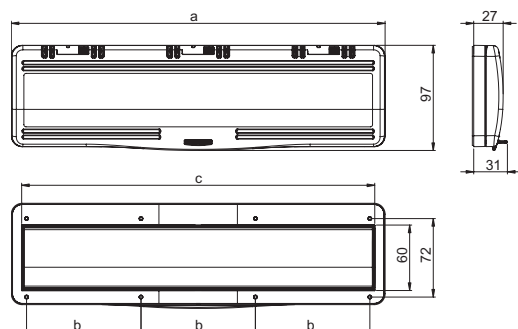

Modules	a (mm)	b (mm)	c (mm)	Weight
18	344	105	324	299

Technical data:

- » especially compact design, made of shock-resistant polycarbonate
- » for distributor's construction, O.E.M's panel builders, etc.
- » self-closing window
- » bearing by means of double hinges
- » angle of vee > 180°
- » mounting frame made of shock-resistant polycarbonate with integrated gasket for flange mounting
- » all metal parts corrosion-resistant
- » transport and installation protection of the window with peel back foil
- » integrated free position for lead seal
- » window holder included
- » Protection degree IP54