



Ground Mounted Charger LS4 (OLEV approved)

Type: LS4DCMT274WO-MC



LS4DCMT274WO-MC

Charging Mode	Mode 3
Socket or Tethered Lead	Socket (type 11) X 2
AC Output Current (A)	6,10,16,20,25,32
Power outlet [kW]	3.7KW,7.4KW
Rated voltage [V AC]	230 / 400
Frequency [Hz]	50
Temperature range [C]	-25...+40
Degree of protection (IP)	54
Weight(KG)	24.5
Location	Ground / Wall mounted
DC Monitoring	Yes,
Load management	Standard with GNM3D / 3T
Local Meter	Standard
Communication	4G
RFID	Standard
Protocol	OCPP1.5 / 1.6
Certification	EN 61851-1, IEC 61439-7

Master Socket

Slave Socket

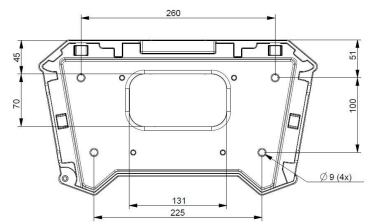
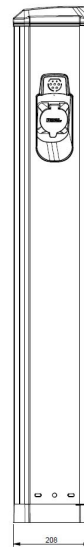
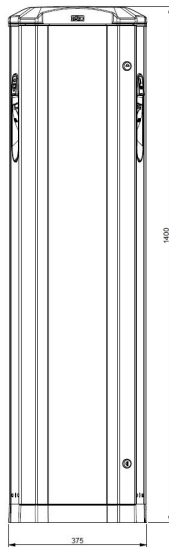
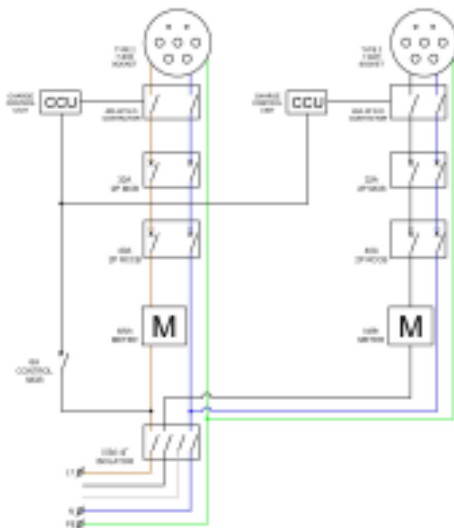



Dokument/document		Utgåva datum/edition date
Försäkran om överensstämmelse/ Declaration of conformity		2015-05-04
Avdelning/department Kvalitet/Quality		
Ansvarig/prepared	Version	Sida/page
Kent Andersson	4	1 av/of 1

Manufacturerer/Tillverkare: GARO AB
Box 203
S-335 25 GNOSJÖ
Sweden

Telephone: +46 (0)370 33 28 00
Telefax: +46 (0)370 33 28 50

Agent established within EC/Ombud etablerad inom EG

Agent of equipment/Materielslag: Electric Charging Station for EV/Laddstation för elbil

Trade Mark/Varumärke: GARO

Type Designation/Typbeteckning:

GARO Charger LS4 Product code: LS4 DC M T 274-222 WO - LAN - MC - C
Product code: LS4M-T222W 4G - AU - AUC

We hereby declare that our product fulfils the requirements of following EC directives/
Vi intygar härmed att vår produkt uppfyller krav enligt följande EU direktiv:

- The Low Voltage Directive (LVD) 2014/35/EU / Lågspänningsdirektivet (LVD) 2014/35/EU.
- Electromagnetic compatibility (EMC) 2014/30/EU / Elektromagnetisk kompatibilitet (EMC) 2014/30/EU.
- RoHS Directive (RoHS) 2011/65/EU / RoHS direktivet (RoHS) 2011/65/EU.
- No electromagnetic compatibility (EMC 2014/30/EU) immunity or emission tests are required on the assembly / Produkten innehåller inte elektroniska apparater som påverkas enligt förbehållen enligt direktivet (EMC) 2014/30/EU.

The following harmonised standards (latest edition) or technical specifications which comply with good engineering practice in safety matters in force within the EC have been used in the design:/

Följande harmoniserade standarder (senaste utgåva) eller tekniska specifikationer som uppfyller god säkerhetsteknik praxis inom EG har använts i konstruktionen: IEC 61851-1 och IEC TS 61439-7

- The equipment confirms completely with the above stated harmonised standards or technical specifications./
Materielen överensstämmer helt med ovan angivna harmoniserade standarder eller tekniska specifikationer.

Or/Eller

The equipment confirms only partially with the above stated harmonised standards or technical specifications but complies with good practice in safety matters in force within the EC./

Materielen överensstämmer endast delvis med ovan angivna harmoniserade standarder eller tekniska specifikationer, men uppfyller god säkerhetsteknisk praxis inom EG.

We have product surveillance according to CENELEC's harmonised requirements, documents CCA-201.

GARO AB
Company/Företag

2016-05-12
Date/Datum

Sign/Underskrift

Responsible for Technology and standardization/Teknik och standardiseringsansvarig
Position/Befattning

Kent Andersson
Sign in printed letters/Namnförtydligande